

Omni Cubed Europe

QUALITY MATERIAL HANDLING EQUIPMENT



GLASS
EDITION

TOOLS THAT LAST
**SAFETY, EFFICIENCY
AND LONGEVITY**

PRODUCT CATALOGUE



FOREWORD

Derek Westlund, CEO, Omni Cubed Inc.

Thank you for choosing Omni Cubed products. Our purpose - the "why" behind what we do - is to help talented craftsmen by providing them with innovative, practical tools, that enable them to work safely, efficiently, and be more profitable.

Our vision is to be the most trusted provider of stone and glass fabrication and installation tools in the world. We strive to propel ourselves and our industry forward by supplying our valued customers with new and innovative tools that enable them to conquer the challenges of today, as well as those on the horizon. We don't just focus on new products and forget about our existing ones; we routinely assess our entire product line for ways to make our tools even better and bring greater value to our customers.

Please don't hesitate to contact us if you have questions or would like more information about our company or products, or to share your feedback about any of our products you've used.



HOW TO ORDER

We understand that no two companies are the same, and we strive to reflect this in all aspects of our customer service.

We provide the flexibility to order in the way that suits your business. In this age of e-commerce, our fully functioning website is our storefront, where you can safely and securely place an order at any time you choose.

Alternatively you can contact the office and place your order over the phone by calling +44 (0)845 544 0587, or by email - hello@omnicubedeurope.com

Our friendly and knowledgeable team is always on hand to help you.

DESPATCH AND DELIVERY

We know how quickly you want your tools, so all orders placed and paid for before 1.00pm are shipped the same day (subject to stock). International customers must provide a valid VAT/tax number to allow the export of your tools. Items are shipped on receipt of full payment.

DEDICATED SALES TEAM

Our fully trained sales staff are ready to take your calls from 8.30am to 4.30pm Monday to Friday. They can offer advice and guidance on all our products.

HOW TO PAY

Our secure payment portal on the website means you can pay for your tools immediately via all major credit cards. This is the fastest way to ensure your tools get to you quickest. Alternatively, an invoice can be raised in either GBP or EUR to allow you to pay by bank transfer if you prefer.

WARRANTY

Omni Cubed Europe Ltd warranties our products with the original owner for one year from the original purchase date. This warranty covers defects in workmanship and materials arising from normal usage. Misuse and normal wear-and-tear components are not covered under this warranty.

Please contact Omni Cubed® customer service or Omni Cubed Europe Ltd. for warranty services.

Order online at www.omnicubedeurope.com or call +44 (0) 845 544 0587

**TOOLS THAT LAST
 SAFETY, EFFICIENCY, LONGEVITY**

Omni Cubed® builds tools with a purpose - to help you excel.

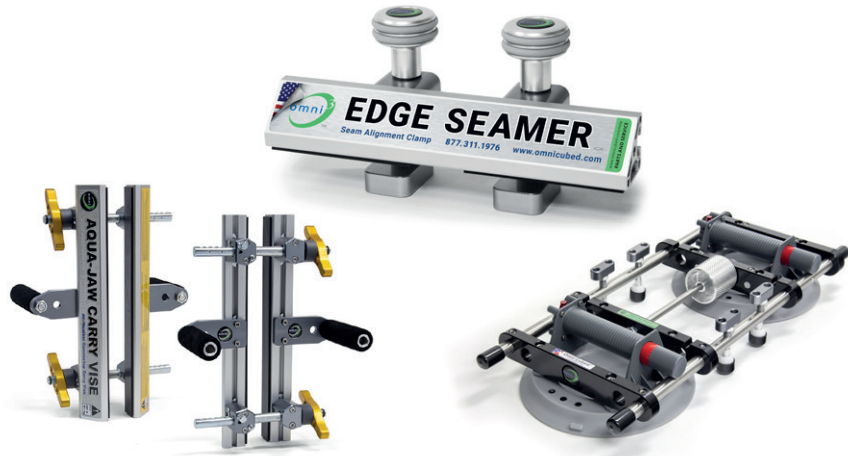

We are passionate about helping talented craftsmen in the glass and stone industries by providing innovative, practical tools that enable you to work safely.

You can rely on our excellent standard of engineering and manufacturing in our Northern California facility, because it's our job to make sure only the safest, most reliable tools get into your hands.

Omni Cubed products are made in the USA from domestic and imported parts.

Every tool is engineered to promote safety, efficiency and longevity in your trade.

CONTENTS

Material Reinforcement	5	Tape	17
Carry Clamps	12	Transport Carts	18
Seam Setters	13	Vacuum Cups	22

S3 | SLIM SLAB SAVER™ AUTO

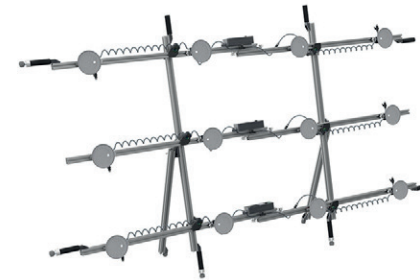

- The S3 is an inexpensive insurance policy that pays for itself with one prevented break™
- Versatile, completely customisable rigid frame and reinforcement system
- Promotes safer, more ergonomic lifting and moving to reduce strain and injury
- Ideal for glass, thin format material, gauged or thin porcelain slabs, and sintered stone such as Dekton® and Neolith®
- A powerful yet compact vacuum pump on each adjustable rail allows installers to focus on the task at hand without having to manually maintain vacuum pressure
- VMP750 pump features a built-in, rechargeable Li-ion battery that runs for up to 5 continuous hours on a single charge, and provides worry-free vacuum pressure for each rail in the system
- Faster, safer, and more convenient than manual pressure maintenance
- Lightweight with extreme strength and rigidity
- Completely customisable system for creating rigid frames to support sheets of glass and other fragile materials
- Cups, clamps, and rails can be arranged in many configurations to reinforce uniquely shaped pieces
- Non-marking 6" cups feature a concave design for quick attachment, even to bowed surfaces
- Safely remove glass without breakages and fractures
- FTS™ (flexible triple seal) vacuum cups provide secure, reliable hold
- Kickstand Kit accessory (included with 3-Rail models) allows upright resting of material
- Durable, UV-resistant foam grips provide a comfortable handle for safer, more ergonomic transport and placement of materials
- Rails extend from 160 - 312 cm
- Each adjustable rail is rated to handle up to 90 kg

S3 | SLIM SLAB SAVER™ AUTO



Stock Code S3-1A-19
Size 1-Rail



Stock Code S3-2A-19
Size 2-Rail



Stock Code S3-3A-19
Size 3-Rail

S3 | SLIM SLAB SAVER™ MANUAL

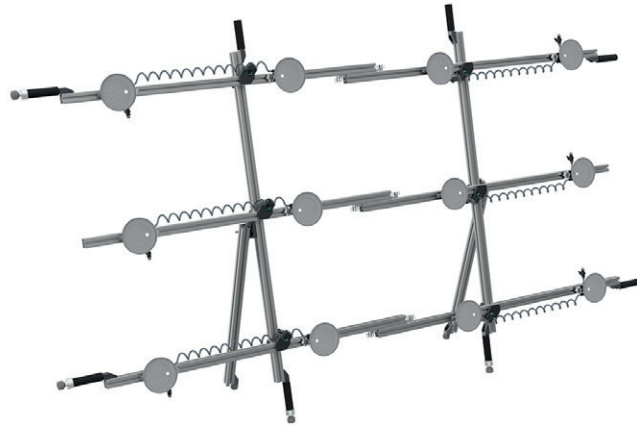

- The S3 is an inexpensive insurance policy that pays for itself with one prevented break™
- Promotes safer, more ergonomic lifting and moving to reduce strain and injury
- Ideal for glass, thin format material, gauged or thin porcelain slabs, and sintered stone such as Dekton®
- Lightweight with extreme strength and rigidity
- Completely customisable system for creating rigid frames to support sheets of glass and other fragile materials
- Cups, clamps, and rails can be arranged in many configurations to reinforce uniquely shaped pieces
- Non-marking 6" cups feature a concave design for quick attachment, even to bowed surfaces
- Safely remove glass without breakages and fractures
- FTST™ (flexible triple seal) vacuum cups provide secure, reliable hold
- Kickstand Kit accessory (included with 3-Rail models) allows upright resting of material
- Durable, UV-resistant foam grips provide a comfortable handle for safer, more ergonomic transport and placement of materials
- Rails extend from 160 - 312cm
- Each adjustable rail is rated to handle up to 90 kg
- Includes all components to easily convert and upgrade to Auto system (no tools required)

S3 | SLIM SLAB SAVER™ MANUAL



Stock Code	Size
S3-1M-19	1-Rail



Stock Code	Size
S3-2M-19	2-Rail



Stock Code	Size
S3-3M-19	3-Rail

Order online at www.omnicubedeurope.com or call +44 (0) 845 544 0587

SLIM SLAB TABLE HD



The sturdiest large format thin material table on the market today

- Ultra-rigid table that provides a flat, non-slip surface for safe fabrication
- Reduce the strain of bending, kneeling, or overstretching, as well as preventing bowing of the materials thus avoiding cracks or breakage
- Ideal for glass, gauged or thin porcelain slabs and sintered stone such as Dekton® and Neolith®
- Pitched and bolted legs provide more stability than collapsible legs, yet quickly detach for transport
- Easy-adjust levelling feet make setting up on uneven floors a breeze
- Comfortable work height makes all-day fabrication easier and reduces worker strain
- Non-marking synthetic rubber support pucks firmly hold material
- Bump stop posts keep smaller pieces from sliding while doing edge work
- Tables can be connected with brackets (provided) to accommodate longer material
- Tool Shelf (sold separately) provides convenient access to tools and equipment
- Each table top is 1.8m x 1.5m and can accommodate panels up to 272 kg when evenly distributed

Stock Code SST-HD-20

SLIM SLAB TABLE TOOL SHELF

The Slim Slab Table Tool Shelf easily attaches to the rails of the Slim Slab Table HD for convenient access to your tools.



Stock Code SST-TS-20

Order online at www.omnicubedeurope.com or call +44 (0) 845 544 0587

ACCESSORIES

EXTENSION SLIDE BRACKET

The Extension Slide Bracket combines any two Omni Cubed vacuum cup reinforcement rails into one adjustable-length rail for greater versatility and convenience. Reposition or remove vacuum cups as needed for extra range.

Stock Code ESB-19



HORIZONTAL LIFTING HANDLE KIT

The Horizontal Lifting Handle Kit includes two handles that provide a comfortable gripping point at each end of any Omni Cubed reinforcement rail for more ergonomic lifting, moving, and tilting of glass.

Stock Code HLH-19



HORIZONTAL HANDLE WITH LEVELLER LEG KIT

The Horizontal Handle with Leveller Leg Kit includes two handles with adjustable levelling legs and incorporated PVC "resting feet" that won't scratch finished surfaces.

These handles can be mounted at the ends of any Omni Cubed reinforcement rail to easily level pieces in an upright position for more accurate glass panel installations.

Stock Code HLL-19



KICKSTAND KIT

The Kickstand Kit is a pair of kickstands (one left, one right) that can be used with Omni Cubed's Slim Slab Savers or vacuum cup Sink Hole Savers to allow upright resting of material for easier and more ergonomic application of mortar or adhesive. The integrated PVC resting feet won't scratch finished surfaces.

Stock Code KS-19



RECHARGEABLE POWER PACK KIT



- The Rechargeable Power Pack features a 12v Li-ion battery that lasts up to 5 continuous hours on a single charge, and has an LCD display showing the remaining power level, so you never have to wonder if your battery will last through another install.
- The Rechargeable Power Pack is compatible with any Omni Cubed vacuum pump (excluding VMP750 which has built-in Li-ion battery).

Stock Code RPP300-KIT-17

RIGID CROSS-BRACE KIT

Ideal for glass



- Pays for itself with one prevented break™
- Ideal for glass, gauged porcelain slabs such as Laminam®, and sintered stone such as Neolith® or Dekton®
- Attach vacuum cup reinforcement rails perpendicular to each other at various locations, allowing customised configurations to reinforce large, fragile, or uniquely shaped pieces.
- Minimises twisting and flexing of material in multiple directions
- Sturdier than just using unconnected rails
- Integrated "resting feet" won't scratch surfaces when material is flipped upside-down

The 3' Rigid Cross-Brace Kit includes two 3' cross-brace rails and four rigid clamps that attach any two Omni Cubed® vacuum cup material reinforcement rails to form a sturdy support frame for glass panels. A convenient carrying bag for the clamps is included.

Stock Code RCB-S4-19

ROTATING CUP ARM™



With the Rotating Cup Arm™, you will find there is no shape or size glass that can't be reinforced and protected!

Simply attach the Rotating Cup Arm™ to the extrusion on any of our material reinforcement products, including the entire Sink Hole Saver™ cup line and the Slim Slab Saver™ line.

- Pays for itself with one prevented break™
- Boost your lifting capacity by an extra 31kg, as well as adding more structural reinforcement!
- Small enough to fit where a standard Sink Hole Saver™ can't
- Can be rotated up to 180° - giving you the freedom to find the angle that works just right for your piece
- A perfect solution for just about any size or shape glass panel and other fragile materials with large cutouts
- Non-marking 6" cup featuring a concave design for quick attachment, even to bowed surfaces
- FTS™ (flexible triple seal) vacuum cups provide secure, reliable hold on materials
- High flow vacuum release valves for fast and hassle-free removal of product
- Vacuum cups can be easily repositioned along material or around cutouts

Stock Code RCA-20

SINK HOLE SAVER™ ANGLE BRACKET

The Sink Hole Saver™ Angle Bracket connects any two Sink Hole Savers to create a rigid joint at any angle up to 270° for safe transportation of unique shapes.



Stock Code AB-SHS

VERTICAL LIFTING HANDLE KIT

The Vertical Lifting Handle attaches to any Omni Cubed vacuum-cup model material reinforcement rail.

- Durable foam grips provide comfortable handles for safer, more ergonomic vertical panel installations.



Stock Code VLH-19

VMP750 RECHARGEABLE PUMP

The VMP750 is a powerful yet compact rail-mounted rechargeable pump that allows installers to focus on the task at hand without having to manually maintain vacuum pressure.

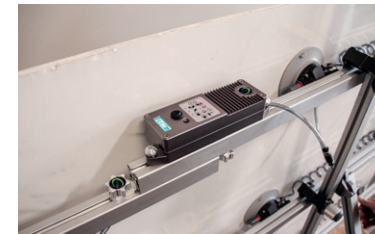

- Using an automated vacuum is faster, safer, and more convenient than manual pressure maintenance.
- The VMP750 pump features a built-in, rechargeable Li-ion battery that runs for up to 5 continuous hours on a single charge, and provides worry-free vacuum pressure for each rail in the system.
- An integrated LCD display shows the remaining power level, so you don't have to wonder if the battery will last through another install.



Stock Code VMP750-19 VMP750 Rechargeable Pump

AQUA-JAW™ CARRY VISE™

The Aqua-Jaw™ Carry Vise™ promotes safer, more ergonomic lifting and moving to reduce strain and injury.



This is the only all-weather carrying clamp designed to hold firm on wet panels, and its super-strong vice action allows for carrying glass up stairs and other slanted or challenging terrains.

Aqua-Jaws are the highest capacity carry clamps on the market, accommodating up to 362kg per pair.

The clamps open wide (4mm-108mm) for thick edges and mitres, and have an optional Handle Kit which allows four people to share heavier loads. Dual quick-spin tightening handles easily secure the product in place, and rubber-lined gripping rails protect tops from scratches.

Stock Code AJ-128-15 Aqua-Jaw™ Carry Vise™

AQUA-JAW™ HANDLE KIT

The Aqua-Jaw™ Handle Kit accessory adds two more handles to each Aqua-Jaw Carry Vise, enabling four people to share the load. One set includes four handles (enough for two vises).



Stock Code AJ-128-HK-15 Aqua-Jaw™ Handle Kit

SEAM SETTERS EDGE SEAMER



- Dial-in flawless edge seams along material edges
- Perfect solution for levelling seams along any edge to ensure a consistent, even joint
- Fast, easy, and more reliable than shims alone - with much greater precision!
- Integrated rail pads for fine-tuning adjustment to compensate for even the slightest unevenness
- Rubber bumpers protect finished edges
- Clamping range: 14 mm - 50 mm

101-ES-17 Edge Seamer

Use alone or in conjunction with your favourite Omni Cubed seam setter.

90° STEALTH SEAMER™

- Consistently create high-quality, expertly aligned perpendicular seams
- Ideal solution for internal and external corners
- Non-marking, proprietary synthetic rubber cups are highly-durable and feature FTS™ technology for optimum hold, even on textured and leathered materials
- Smooth turning knurled rollers and fine-tune levellers help align and dial-in precise angles for expert alignment
- Counter-pressure leveller overcomes lower outswing of vertical pieces

Auto

Ideal solution for internal and external corners

- Includes Anchor Cup Attachments to accommodate large pieces
- Anchor Cup Attachments can also be used independently as a non-marking carrying device!
- Powerful, compact pump maintains max pressure for entire system - set the mitre and walk away with confidence!
- Runs on AC power or AA batteries for any situation
- Sold individually; not recommended for heavy material



5145-90A-17 Auto 90° Stealth Seamer™ Auto

Compact Auto

- Powerful, compact pump maintains max pressure for entire system - set the mitre and walk away with confidence!
- Runs on AC power or AA batteries for any situation
- Sold in pairs with a convenient storage case; recommended for porous and non-porous materials.
- Excludes Anchor Cup Attachments.

5145-90AC-17 Compact Auto

Manual

- Easy to read indicators to monitor vacuum pressure at a glance
- Cups can be re-pumped without loss of remaining pressure
- Sold individually; not recommended for porous material or heavy waterfall pieces (see 90° Auto for these applications).

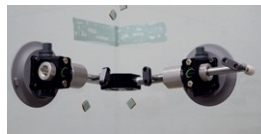

5145-90M-17 Manual 90° Stealth Seamer™ Manual

NANO STEALTH SEAMER™

- Consistently create high-quality, even seams
- More control and less effort than shims and screws
- 5" cups allow seaming smaller pieces and tighter spaces
- Non-marking, proprietary synthetic rubber cups are highly-durable and feature FTS™ technology for optimum hold, even on textured and leathered materials
- Wide-open design means extreme easy access to seams for epoxy application and removal
- Non-spinning levelling feet protect against surface scratches
- Smooth-turning knurled roller opens and closes seams with ease

Auto

Powerful, compact pump maintains max pressure for entire system - set the seam and walk away with full confidence!

- Runs on AC power or AA batteries for any situation

Recommended for porous and non-porous materials.

5148-SNA-17 Nano Stealth Seamer™ Auto



Manual

Easy to read indicators help monitor vacuum pressure at a glance

- Re-pump cups without loss of remaining pressure
- Use alone for short seams, or in multiples for longer seams
- Sold individually

Recommended for non-porous materials.

5148-SNM-17 Nano Stealth Seamer™ Manual



PRO STEALTH SEAMER™

The key to completing a “seamless” installation

- Accessible design means your entire seam is accessible while product is in use
- Rechargeable Power Pack Kit (sold separately) delivers power to your Pro Stealth Seamer Auto for up to 5 hours on a single charge. Guaranteed dependability when there's no access to AC power
- Cups feature completely closed, triple sealing rings and are composed of a proprietary rubber
- Fine-tune the seam and eliminate unevenness
- Easy to read indicators help monitor vacuum pressure at a glance
- Non-spinning, vinyl-capped levelling feet protect material
- Smooth-turning knurled roller opens and closes seams with ease
- Durable anodised billet aluminium and stainless steel components



Auto

- Eight levelling points to fine-tune the seam and eliminate uneven materials
- Compact vacuum pump runs on AC or battery power and maintains pressure for entire system
- Quick-connect fittings for easy setup, and simple conversion to manual mode
- Auto system includes a powerful compact vacuum pump that maintains pressure for all cups, and runs on AC power or AA batteries for any install situation.

8129-PSA-19 Pro Stealth Seamer™ Auto



Manual

- Four levelling points to fine-tune the seam and eliminate unevenness
- Easy to read indicators help monitor vacuum pressure at a glance
- Cups can be re-pumped in place, without removal and without loss of remaining pressure

8129-PSM-19 Pro Stealth Seamer™
Manual

TAPE

KUNG FU TAPE™

Combats the problems that traditional tapes cause. Say goodbye to sticky residue, difficult to tear edges, and a weak hold.



- Unique serrated edges for easy tearing
- Leaves no residue upon removal up to 10 days* after application
- Strong yet flexible - conforms to edges and corners
- Stretchy - holds seams tight (acts like a clamp)
- Gentle on materials
- Leaves no ghosting or shadows on your material
- Quickly and cleanly removed* after application, saving you from the pains of scraping and cleaning your glass, and saving valuable time!
- Easy to adjust your seam - easily reapplied (even in cold weather conditions) with great adhesion unlike many other tapes that lose their hold if you try to readjust them
- Write on Kung Fu Tape™ without any ink transfer or bleeding to the material beneath, making it a simple and inexpensive waterproof label that is ideal for wet workshops
- No curling, splintering or fraying
- Non-marking
- Waterproof
- Excellent low-temp bonding
- Just as great for floor installation, cabinet building, woodworking, glass handling, tile setting, and so much more!
- 48mm x 55m per roll

KFT5300011x Single roll (48mm x 55m)

KFT53000120x 20-pack (48mm x 55m per roll)

*Indoor vs. Outdoor Use:

- Indoor Use: Clean removal up to 6 months or more
 - Outdoor Use/UV Exposure: Clean removal up to 10 days
- Test on scrap material prior to use for safety and best results



TRANSPORT CARTS



Reduce strain and risk of injury and overcome the challenges of moving glass over kerbs, stairs and other rough terrain such as gravel and lawns, while safely and easily transporting your fragile material.

All of Omni Cubed's transport solutions are aircraft grade aluminium constructed bringing you super strength and stability in a lightweight dolly or cart. And all of these transport options clamp to your material during transport, meaning your wheels and material are securely paired even when lifting over kerbs or up stairs.

Use with the Aqua-Jaw™ Carry Vise™ and a Sink Hole Saver™ for the ultimate installation kit!

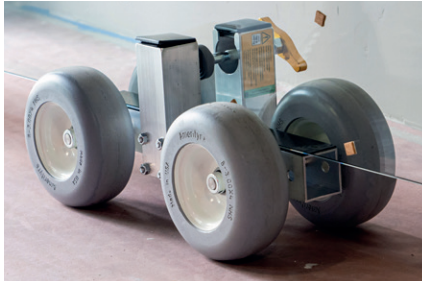

PRO-DOLLY™ HD1

Heavy duty dolly



- 340kg capacity; weighs only 9.5kg
- Low profile provides more height clearance for tall pieces through doorways
- Extremely stable and easy to manoeuvre
- 8" non-marking, flat-free, shock absorbing tyres
- Clamp opening: 73 mm
- Often used in pairs to handle extra large pieces (up to 680kg)

PDHD1 PRO-DOLLY™ HD1

PRO-DOLLY™ HD2

Super-duty dolly

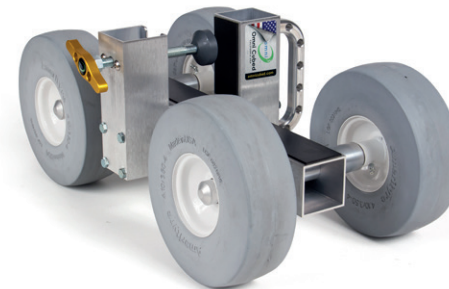

- 450kg capacity; weighs less than 16kg
- Low profile allows more clearance for tall pieces through doorways
- Wide clamp opening for thick material
- Extremely stable and easy to manoeuvre
- 10" non-marking, flat-free, shock absorbing tyres
- Clamp opening: 130 mm

PDHD2 PRO-DOLLY™ HD2

PRO-CART AT1

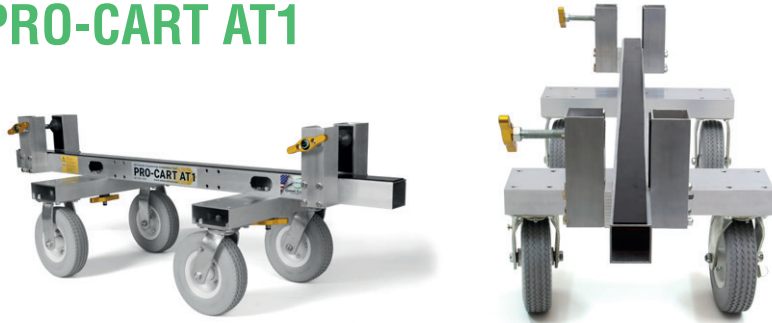

- Easily manoeuvrable, and can be operated by a single person in many cases
- High ground clearance ensures you easily clear and rest on stair treads
- 340kg capacity, weighs less than 23kg
- 8" non-marking, flat-free, shock absorbing tyres
- Folding Kit (sold separately) collapses cart to under 10" wide
- Multi-Top Accessory available (sold separately)

PCAT1-14 PRO-CART AT1

PRO-CART AT2



- Equipped with all the same features as the Pro-Cart AT1 model, with several convenient and helpful additions
- Innovative, adjustable wheelbase which can be tailored to match variable stair treads
- Designed to easily clear and rest on stair treads
- Collapsible clamp uprights for easy removal and tilting of glass
- 450kg capacity, weighs less than 30kg
- 10" non-marking, flat-free, shock absorbing tyres
- Included Folding Kit collapses cart to under 13" wide
- Multi-Top Accessory available (sold separately)

PCAT2-14 PRO-CART AT2

PRO-LIFT AUTOMATIC SUPER-DUTY LIFTING CART

Every aspect of this cart has been designed with safety, ease, and convenience in mind - providing immeasurable benefit to small and large workshops.

- A safer means of transporting and installing heavy glass
- Reduce physical strain and risk of injury, while increasing productivity and efficiency
- Accomplish more with less people
- Safely lower, transport, and lift large panels
- Enables controlled tilt for easier glass worktop installation
- Wireless remote allows workers to position themselves in safer areas around the glass
- Commonly used with Aqua-Jaw™ Carry Vise™ for optimal material control
- Unload slabs easier, safer, and faster than traditional methods
- Engineered for optimum stability and manoeuvrability
- Lift material up to 1.15m (from ground to support rail)
- Clamp opening: 115 mm
- Powered by long-lasting 28v rechargeable lithium-ion battery
- 450kg capacity; weighs under 34kg
- 10" non-marking, flat-free, shock absorbing tyres
- Integrated remote storage cage, level, and kickbrake

PLA-140-INTL PRO-LIFT AUTOMATIC

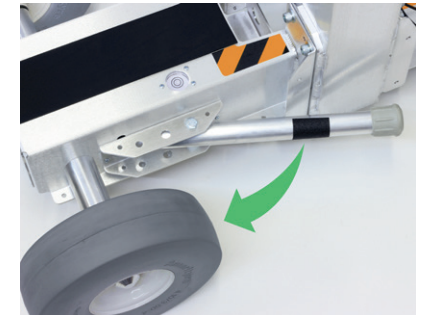

ACCESSORIES

PRO-CART AT1 FOLDING KIT

The Pro-Cart AT1 Folding Kit is an upgrade accessory that allows the cart casters to be rotated under the main support rail, allowing for even easier storage (reduces cart width to less than 10" wide).

PCAT1-FK-14



PRO-CART MULTI-TOP ACCESSORY (FOR AT1 AND AT2)

The Pro-Cart Multi-Top Accessory enables transportation of multiple worktops simultaneously on any Omni Cubed Pro-Cart for increased efficiency, and have an innovative, balanced design to prevent tipping.

Uprights provide elongated padded support rails and can be quickly added or removed using the cart's built-in material clamps.

Each set includes two upright support rails (two used per cart).

PCAT1-MTA



VACUUM CUPS

STEALTH GRIP™

Large 8" cups provide a reliable and convenient hand-hold on flat surfaces such as glass and other heavy materials. Non-marking, proprietary synthetic rubber cups are highly durable and feature FTS™ technology for optimum hold, even on textured and leathered materials.

Cups retain necessary durability such as UV, weather, and tear resistance.

Handle and thumb pump are non-rusting and made of a unique plastic compound that is highly resistant to solvents (compared to metal or ABS handles used on other vacuum cups).

Easy-to-read, large red indicators help monitor vacuum pressure at a glance.

Cups can be re-pumped in place, without removal or loss of remaining pressure.

Sold in pairs with a convenient storage bucket.

SGB-147-19



Helping you deliver quality

We're here to help! If you have any questions, concerns or parts and service needs, please contact us directly.

UK & EUROPE:

Tel: +44 (0)845 544 0587

E: hello@omnicubedeurope.com

Unit D3 Grovehill Ind Est.,
Annie Reed Road,
Beverley, East Yorkshire,
HU17 0LF.
UK

www.omnicubedeurope.com

